

Model G8-92 W/IEC Electric Motor Rotary Gear Pump Unit

Pump Unit Include:

- Model G8-92 Rotary gear pump FM Approved.
- UL listed or Non-listed TEFC Type Electric Motor*.
- Curved Jaw Elastomer Coupling.
- Carbon Steel Coupling Guard RAL3000(standard) or other color on request.
- Carbon Steel Base Plate, RAL3000(standard) or other color on request.

* Junction Box located on top or side of motor

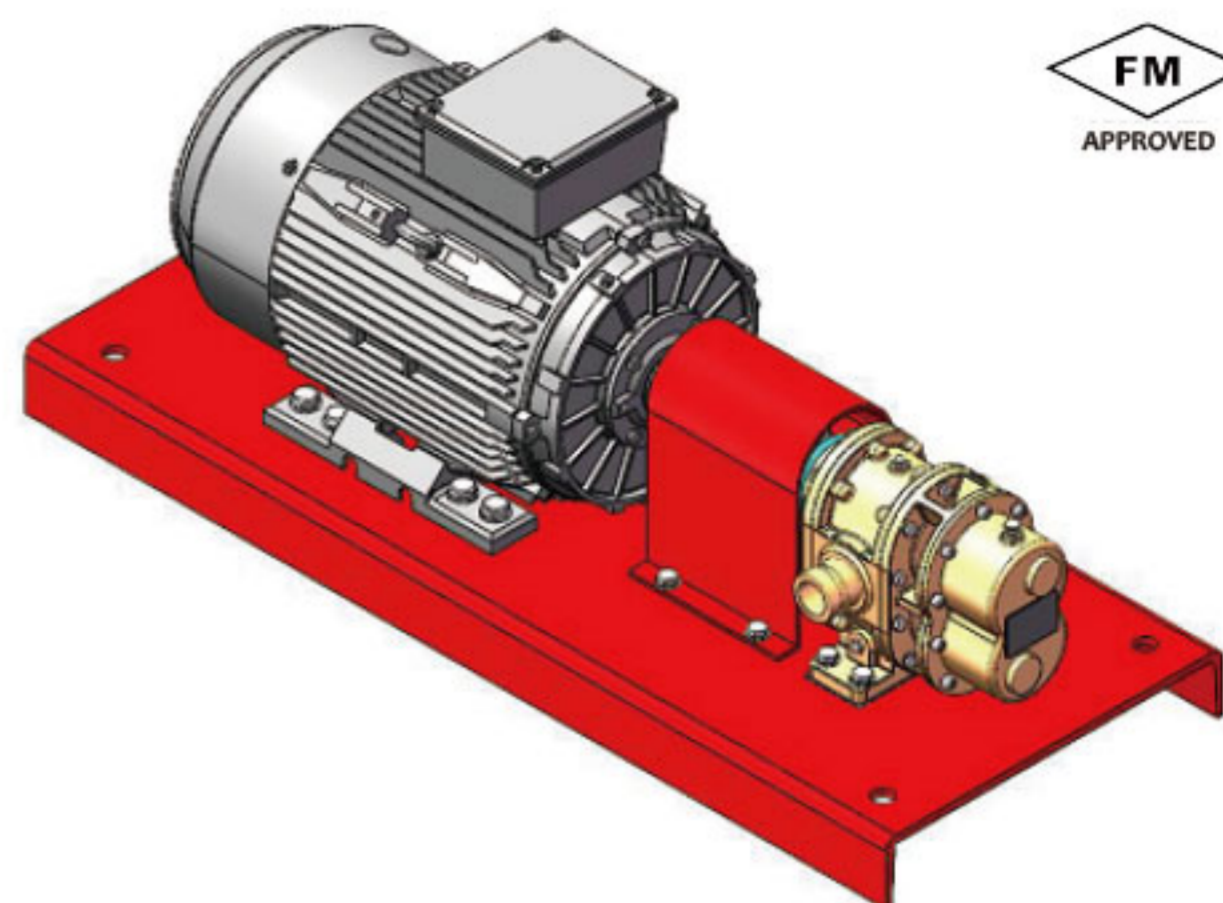

Technical Data:

Speed:	1450RPM
Connection Dia:	DN65(76.1mm O.D)
Connection Type:	Groove, Flange, Thread
Voltage:	380V/3P/50HZ
Enclosure:	IP 56

Performance

Speed	G8-92	
1500rpm	Flow Rate (Water)	Power
Pressure	L/min	Kw
5.0	443.7	8.00
5.5	438.2	8.42
6.0	432.8	8.82
6.5	427.6	9.22
7.0	422.5	9.61
7.5	417.7	9.99
8.0	413.0	10.38
8.5	408.6	10.77
9.0	404.4	11.16
9.5	400.4	11.57
10.0	396.6	12.00
10.5	393.1	12.44
11.0	389.9	12.91
11.5	386.8	13.38
12.0	384.0	13.88
12.5	381.3	14.38
13.0	378.9	14.89
13.5	376.6	15.41
14.0	374.5	15.94
14.5	372.5	16.47
15.0	370.7	17.00
15.5	369.0	17.53
16.0	367.4	18.06
16.5	365.8	18.59
17.0	364.4	19.11
17.5	363.1	19.62
18.0	361.8	20.12
18.5	360.5	20.62
19.0	359.3	21.09
19.5	358.1	21.56
20.0	356.9	22.00

Speed	G8-92	
1500rpm	Flow Rate (Foam)	Power
Pressure	L/min	Kw
5.0	490.1	11.00
5.5	486.3	11.42
6.0	482.5	11.83
6.5	478.9	12.23
7.0	475.4	12.62
7.5	471.9	13.00
8.0	468.6	13.38
8.5	465.3	13.77
9.0	462.2	14.17
9.5	459.1	14.58
10.0	456.2	15.00
10.5	453.3	15.44
11.0	450.5	15.90
11.5	447.8	16.38
12.0	445.2	16.87
12.5	442.7	17.38
13.0	440.3	17.89
13.5	438.0	18.41
14.0	435.8	18.94
14.5	433.7	19.47
15.0	431.7	20.00
15.5	429.8	20.53
16.0	428.0	21.06
16.5	426.2	21.59
17.0	424.6	22.11
17.5	423.1	22.63
18.0	421.7	23.13
18.5	420.5	23.62
19.0	419.3	24.10
19.5	418.2	24.56
20.0	417.2	25.00

Model G8-92 W/IEC Electric Motor Rotary Gear Pump Unit

Dimensions

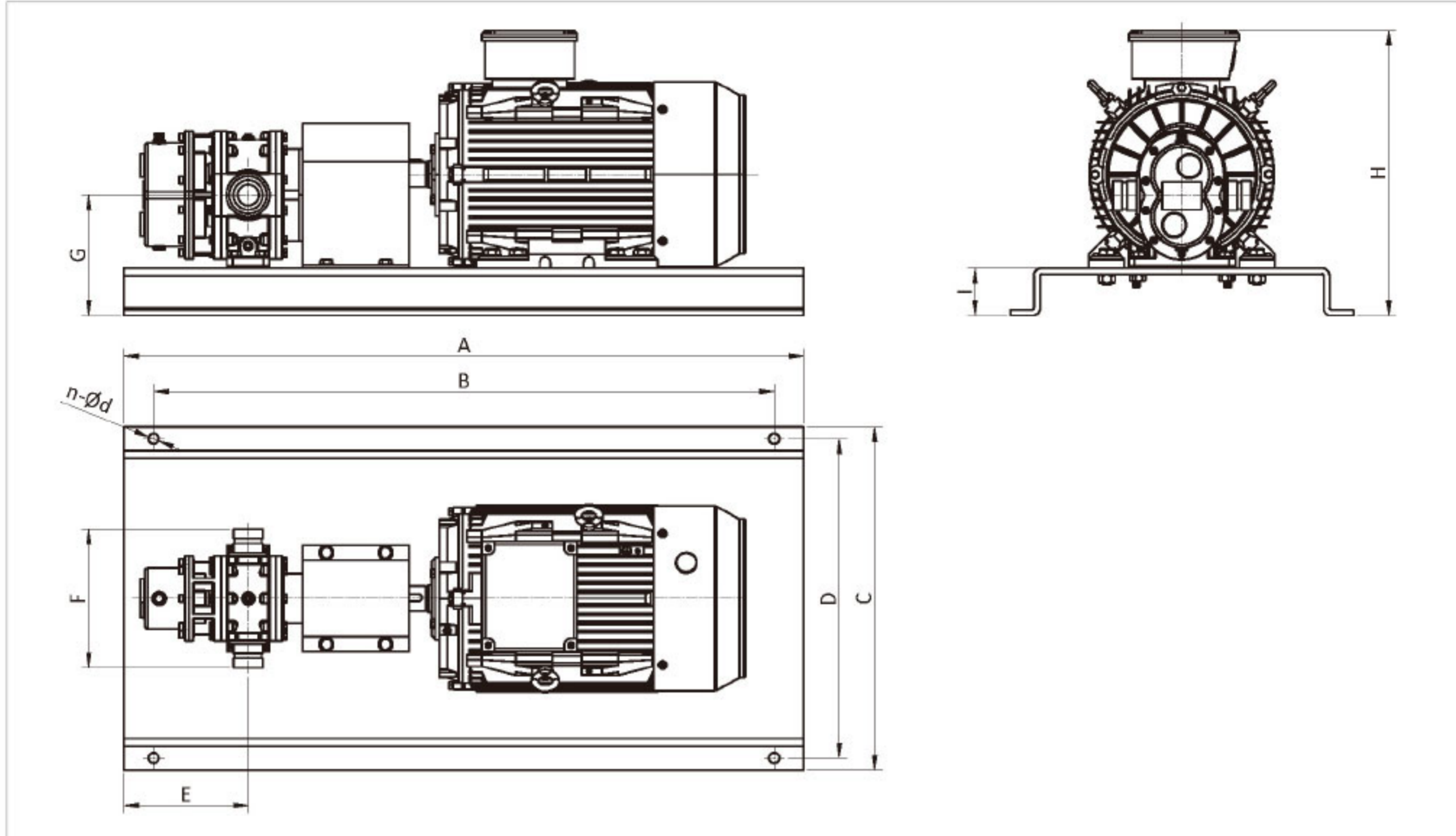

Model	Power	A	B	C	D	E	F	G	H	I	n	d
G8	Kw	mm	mm	mm	mm	mm	mm	mm	mm	mm	-	mm
	11.0	1200	1100	580	540	240	252	209	495	80	4	18
	15.0	1250	1150	580	540	240	252	209	495	80	4	18
	18.5	1270	1170	630	590	240	252	218	525	80	4	18
	22.0	1300	1200	630	590	240	252	218	525	80	4	18
	30.0	1350	1250	700	660	240	252	238	580	80	4	18